



---

# LIORA

---

OWNER'S MANUAL



To prevent PROPERTY DAMAGE, SERIOUS INJURY or DEATH, you should read, understand, and follow the warnings and instructions in this manual. Save a copy for future reference.

# Contents

---

- 3** Important Safety & Usage Information
- 5** Getting to Know Your Adjustable Base
- 7** Parts List
- 8** Base Overview
- 9** Electronic Overview
- 10** Installation Guide
- 13** Remote Control
- 14** Remote Control Programming & Child Lock
- 15** Remote Control Pairing
- 16** Connecting Strap (Optional)
- 17** Syncing Two Bases (Optional)
- 18** Headboard Bracket Installation (Not Included)
- 20** Battery Backup Strap
- 21** Troubleshooting
- 22** 10 Year Limited Warranty

## Contact

1-888-550-3746

[info@ergomotion.com](mailto:info@ergomotion.com)

[ergomotion.com](http://ergomotion.com)

# Important Safety Information



Always read, understand, and follow the warnings and instructions in this manual before using your adjustable bed base.

## **⚠ WARNING**

To prevent electric shock, serious injury, or death:

- ENTRAPMENT HAZARD. This bed can crush and kill when it moves! See Children and Pets section for more information.
- It is recommended to plug the adjustable bed base power cord into a surge protector (not included). The bed base should only be plugged directly into a surge protector (recommended) or into an electrical outlet.
- Always unplug the base from the surge protector or electrical outlet before servicing any part of the adjustable bed base. To reduce risk of electric shock, unplug the base before cleaning. To safely disconnect, ensure the base is in a flat position with all motors off, and unplug from power source. Keep the power cord away from heated surfaces.
- Discontinue use of the bed base and contact a qualified service center if it has a damaged cord or plug, it is not working properly, or it has been exposed to water.
- Only use this bed base for its intended use as described in this manual.
- Do not use accessories/attachments that are not recommended by the manufacturer. Close supervision is required when the bed base is used by or near children, convalescents, disabled persons or pets.
- Improper connection of the equipment can result in the risk of electrical shock, electrical fire or faulty operation of this bed base. If the plug does not fit your electrical outlet, contact a qualified electrician to install a suitable outlet.
- Unauthorized modification or failure to use an electrical outlet or surge protector could void the electrical portion of your warranty.



## **⚠ WARNING**

**CHILDREN AND PETS ENTRAPMENT and CRUSH HAZARDS.**  
Moving parts can crush and kill!

To prevent **SERIOUS INJURY** or **DEATH**:

- Be sure no children or animals are near or under the bed before lowering.
- Always lower to flat (horizontal) position and engage the Child Safety Lock before leaving the room.
- Store remote out of the reach of children.



**Immediately dispose of all packing materials and any plastic bags as these may pose a suffocation risk to children and animals.**

## **PACEMAKERS**

It is **STRONGLY** recommended that individuals with pacemakers or other implanted medical devices consult their physician prior to using products that contain Neodymium magnets.



Some products contain Neodymium magnets which may interfere with medical devices such as pacemakers, implantable cardioverterdefibrillators, and any other device sensitive to magnetic fields.

It is also possible that some pacemakers may falsely interpret the optional massage feature vibrations as movement/exercise. This is a common occurrence with any product that creates a vibrating movement and may affect the pacemaker. Please consult your physician before using the massage feature.

## **IMPORTANT DO'S AND DON'TS**

### **DO:**

- Plug your adjustable base into a surge protector.
- Call Customer Service for any technical issues. Do not try to force the base down, this can damage the motors or frame.
- Keep in mind that adjustable bases are recommended to be used with adjustable friendly mattresses.

# Important Safety Information

- Lower to the flat (horizontal) position after use and in between presets.
- Evenly distribute weight when sleeping in a split setup. Uneven distribution of weight can cause the base to raise unevenly.
- Register your warranty as soon as your adjustable base has been delivered.
- Use mild soap and water to clean your adjustable base if staining occurs.

## **DON'T:**

- Sit on corners/edges of base, this may warp the frame, struts or foam.
- Tilt the base on its side. This can damage the legs and/or leg screws.
- Stand or jump on the adjustable base at any time, this can damage the frame and motors.
- Drag the base to move it. Dragging the base could damage the frame, strip the nut/bolts or break the legs. Purchase castors if you plan on moving your base routinely.
- Enter and exit the adjustable base with the head and/or foot in the articulated position. Enter or exit your adjustable in the flat (horizontal) position.
- Tinker with or modify base. This will void the warranty.
- Pressing down on the head or foot sections while actuated can damage frame and motors.

## **SAFETY FEATURES**

**Manual operation** – If something gets caught in the platform when flattened, you can manually raise the platform up by lifting either the head or the foot section to relieve pressure and allow for release. The motors are designed to lower the mattress by retracting only with gravity, never pulling downwards, which minimizes pinch points.

**Child Safety Lock** – This remote control is programmed with a Child Safety Lock function. Information on locking and unlocking the Child Safety Lock of this feature can be found in the Remote Control Programming & Child Safety Lock section of this manual.

**Emergency stop** – Stop the motion of the platform by pressing any button on the remote control.

**Power outage** – Use the Battery Backup Strap as a temporary power source to get the adjustable bed base to the desired position. Please see the Battery Backup Strap section for more information.

**Casters (optional leg accessory)** – are equipped with locking wheels to prevent unwanted movement. Even when locked, it is possible for the casters to slide.

## **IN-HOME USE AND HOSPITAL STANDARDS**

Ergomotion adjustable bed bases are designed solely for in-home use. This adjustable bed base was not designed as a hospital bed and is not designed to meet hospital standards.



**Do not use this base with TENT TYPE oxygen therapy equipment or near explosive gases.**

## **FCC COMPLIANCE**

**NOTE:** This equipment has been tested and found to comply with the limits for a Class B digital device, pursuant to part 15 of the FCC Rules. These limits are designed to provide reasonable protection against harmful interference in a residential installation. This equipment generates, uses and can radiate radio frequency energy and, if not installed and used in accordance with the instructions, may cause harmful interference to radio communications. However, there is no guarantee that interference will not occur in a particular installation. If this equipment does cause harmful interference to radio or television reception, which can be determined by turning the equipment off and on, the user is encouraged to try to correct the interference by one or more of the following measures:

- Reorient or relocate the receiving antenna.
- Increase the separation between the equipment and receiver.
- Connect the equipment into an outlet on a circuit different from that to which the receiver is connected.
- Consult the dealer or an experienced radio/TV technician for help.

## **SAVE THESE INSTRUCTIONS FOR FUTURE REFERENCE.**

# Getting to Know Your Adjustable Bed Base

## ADJUSTABLE BASE WEIGHT LIMITS

This product is not rated to support weights exceeding a total of 750 lbs. (340 kg), including the mattress and bedding.



**Exceeding this weight limit can damage the adjustable base, cause serious injury, and void the warranty.**

The base can structurally support this weight limit, provided the weight is evenly distributed across the adjustable base. The adjustable base is not designed to support or lift this amount only using either the head or the foot sections.

## LIFTING/LOWERING MECHANISMS

The lift/lower feature will emit a minimal humming sound during operation. This is normal. Tension, pressure or movement applied to the frame, platform or shroud through general use may create audible sounds.

During operation, the lift arm wheels make contact with the platform support of the base. This contact may result in metal on metal or metal on plastic contact. This applies slight tension on the moving components and resonance is reduced to a minimum level. If excessive noise or vibration is experienced, reverse the movement action (up or down) of the base with the remote control. This should realign the base's activating mechanisms to the proper operational position.

In normal base operation, the wheels which allow the bed to maintain its distance from the wall, will make contact with the steel platform supports of the base creating a contact noise. When entering, exiting or shifting weight on the base, this contact noise may be audible as the wheels make contact. This is normal.

## PAIRED OPERATION

When using synchronized adjustable beds, there may be an interval of up to 1.5 seconds between the movements of each bed

## MOTORS

The lift motors are not designed to operate continuously for more than two (2) minutes in an eighteen (18) minute time period or approximately 10% duty cycle. Attempting to circumvent or exceed this rating will shorten the life expectancy of the product and may void the warranty.

The massage motors (if equipped) are not designed to operate continuously for more than thirty (30) minutes at a time. Please allow the massaging system to rest for thirty (30) minutes after automatic massage shut off before restarting.

## TOLERANCE

All Ergomotion adjustable foundations, depending on make and model, are designed and manufactured to perform and function within designated quality control parameters. Bases are subject to meticulous and rigorous inspections during the quality control process to ensure bases will operate within these standards during normal operating use.

Normal operating use is defined as the following: Adjustable foundation is to be operated with a mattress and load. Testing procedures require lifetime cycle tests with up to 265 lbs. (120 kg) distributed load. The angle (designated "α" in figure 1) between the back section and the flat section for various configurations of the mattress support platform shall be  $\pm 3^\circ$ , which translates to a tolerance of up to 1 1/2".

The angle (designated "β" in figure 1) between the flat section and foot section for various configurations of the mattress support platform shall be  $\pm 3^\circ$ , which translates to a tolerance of up to 3/4". Any adjustable foundation deemed to be within these allocated tolerances is considered to have met the manufacturer's quality control standards.

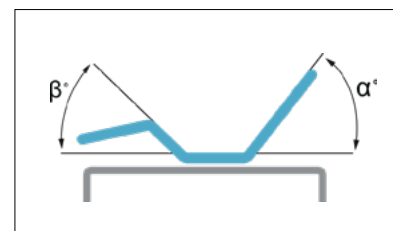

## MATERIALS OF CONSTRUCTION:

Ergomotion adjustable bases are constructed from various materials including woods, metals, plastics and fabrics.

# Getting to Know Your Adjustable Bed Base

## **THAT “NEW PRODUCT” ODOR:**

Some people may notice a slight odor when they receive their new adjustable base.

This odor is normal and usually dissipates before the product is delivered to you. Sometimes, this odor may still be noticeable and should dissipate after a few weeks.

## **BREAK IN PERIOD:**

You can speed up the break-in period by simply spending time in the adjustable bed through activities such as reading, watching TV or playing with the kids or grandkids. The extra movement will help the adjustable base respond to weight and temperature changes.

Some of the materials in our adjustable bases such as the woods, metals and plastics used in the platform, frame and components are sensitive to moisture content and temperature and may make sounds in colder environments.

## **WEAR AND TEAR:**

Wear and tear is damage that naturally and inevitably occurs as a result of normal use or aging. To order replacement parts, contact Customer Service.

## **FABRIC CARE:**

To prolong the life of your fabric, protect from direct sunlight whenever possible. Keep at a minimum of 12 inches (30 cm) away from direct heat sources.











For spot cleaning, wipe area with a light damp sponge or vacuum with a soft brush attachment to remove particles.

For a deeper cleaning, blot liquid spills with a clean dry cloth. Wipe with a clean cloth dampened with warm water. Do not wet excessively or use abrasive or harsh chemicals. A soft bristle brush may be used to remove ingrained soil. Avoid scratching by gentle brushing. Wipe with a clean cloth dampened with warm water to remove residues.

Dry out of direct sunlight and away from direct heat sources. If persistent marks remain visible after cleaning, seek professional advice.

# Parts List

Before discarding the packing materials, ensure all the parts are accounted for. All electronics and components are located in bags under the base or attached to the frame with twist ties or orange zip ties.

<p>A.</p> 	<p>B.</p>  <p>(x6)</p>	<p>C.</p> 	<p>D.</p> <p><b>Power Cord AC</b></p> 
<p>E.</p> 	<p>F ‡</p> 	<p>G ‡</p> 	<p>H.</p> 
<p><b>Misc. Parts (Not Included)</b></p>			
<p>I.</p> 	<p>J.</p> 		

- A. Wireless Remote Controls and AAA Batteries (3)
- B. 12-inch Stackable Legs (6)
- C. Mattress Retainer Bar
- D. Power Cord
- E. Power Supply
- F. Sync Cord ‡
- G. Connecting Strap ‡
- H. Battery Backup Strap (9 Volt Alkaline batteries not included)

**Misc. Parts (Not Included):**

- I. Surge Protector
- J. 9 Volt Alkaline Batteries

‡ Only included with LS bases.

# Base Overview

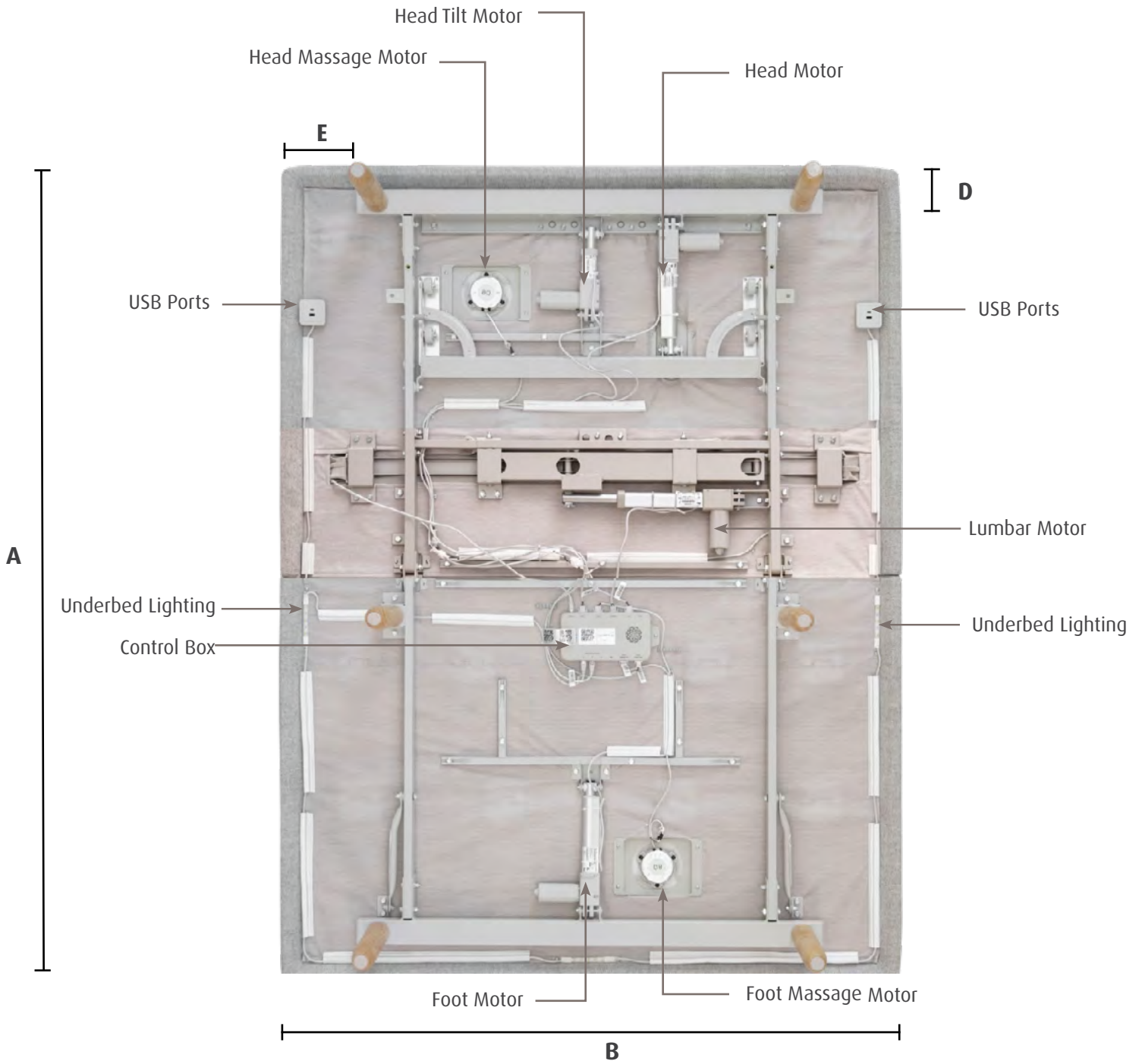

Bed Size	A Length (mm)	B Width (mm)	C Zero Clearance Thickness (mm)	D Distance from Leg to Foot Edge (mm)	E Distance from Leg to Foot Edge (mm)	F Head-Up Angle	G Foot-Up Angle
LS	914	2032	78	122	136	60°	40°
Q	1524	2032	78	135	247	60°	40°

# Electronic Overview

Not to scale. For illustration purposes only. Read all instructions before beginning installation.

For a split base setup, see [pages 16-17](#).



Battery Backup Strap

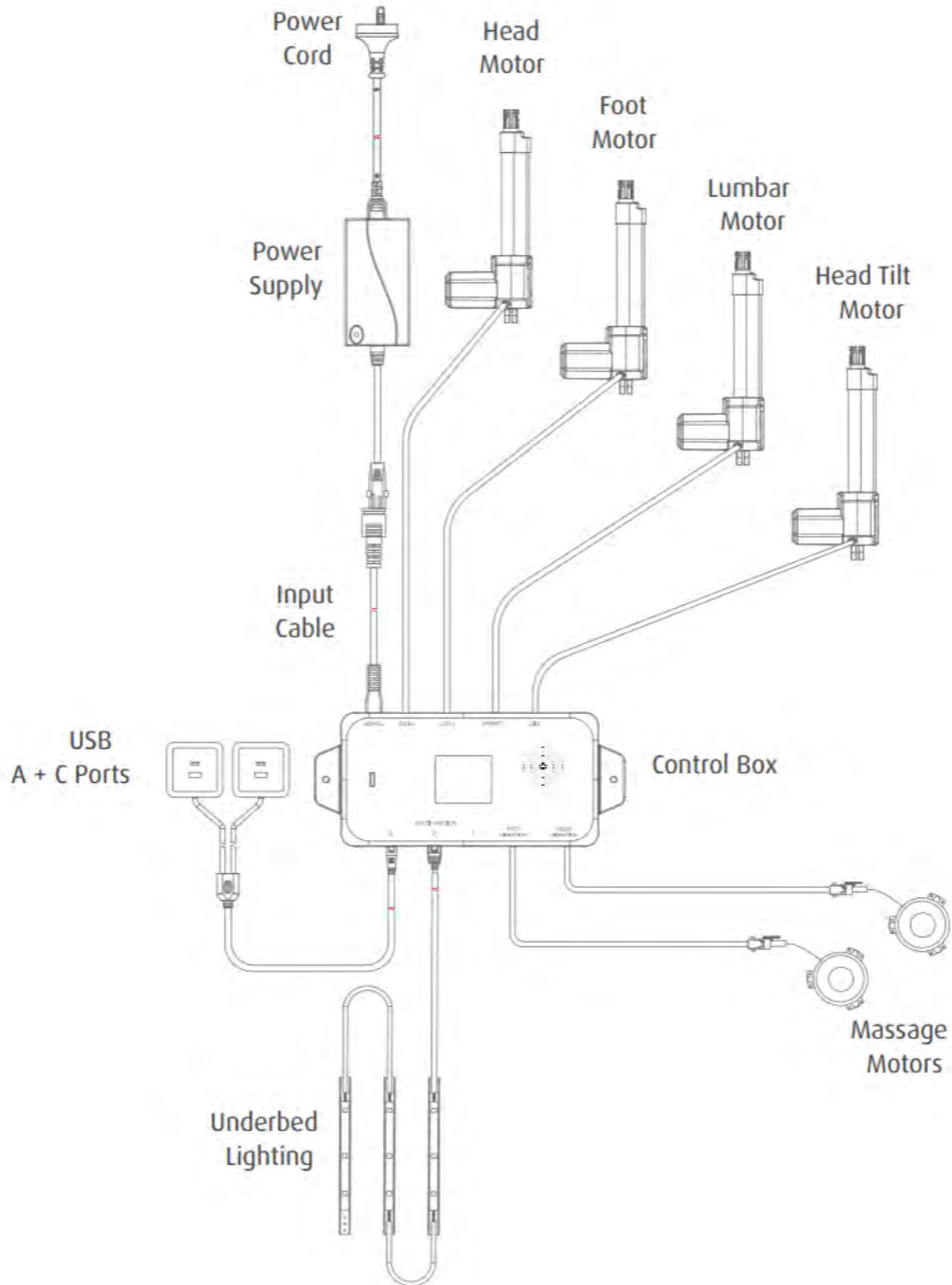

# Installation Guide



Always use two (2) people when setting up the base.



Read all instructions before beginning installation.

---

1 Place the bed base box in a desired location with the bottom of the box facing up. Remove the binding straps and packing materials, making sure not to puncture the box with any sharp objects.

2 Remove the bed base from the box. Unfold the bed making sure to keep the bottom of the bed facing up.

**Note:** To install Headboard Brackets (sold separately), see instructions on [page 18](#).

3 To install the legs, thread the leg into frame, and tighten by hand.

**Note:** Do not over tighten. Too much force may cause the leg to spin freely.

**Note:** Legs are shipped fully assembled. Alternative heights can be achieved by removing leg segments.

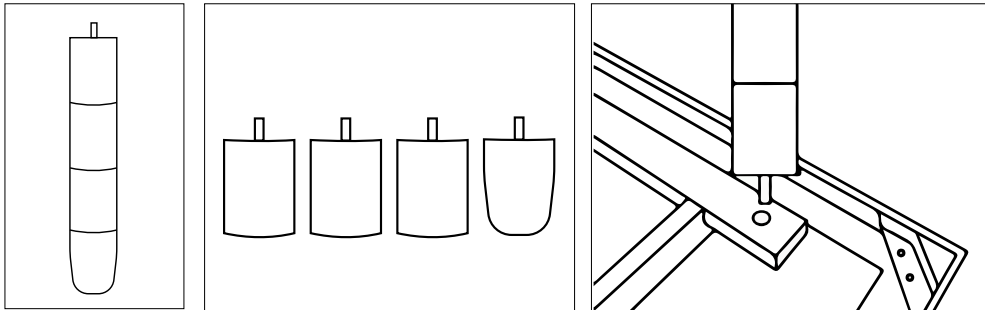

4 Locate the battery backup strap and install (2) 9V Alkaline batteries (not included). Store the strap in a convenient location in case of a power outage. *For operating instructions see [page 20](#).*

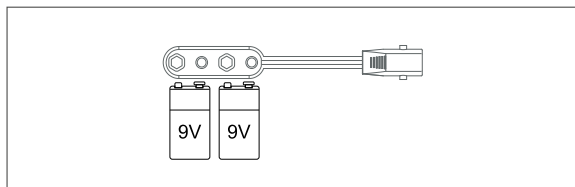

5 Locate the power supply and position it inside the netted pocket.

# Installation Guide (continued)

- 6 Uncoil the input power cord (connected to control box's power port) and plug into the power supply.

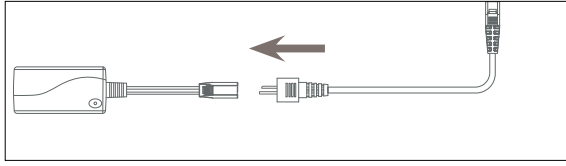

- 7 Uncoil the power cord and connect to the power supply. Place power supply on the ground and extend from the base. Check the power supply and all attached cords are directed toward the location of the surge protector (recommended) or power outlet.

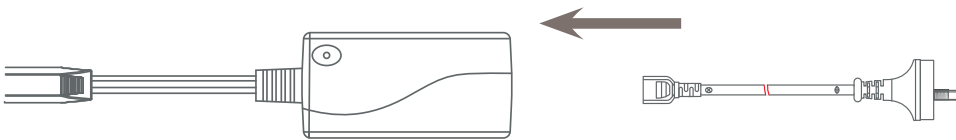

- 8 Carefully rotate the base over on to its legs.



**Two (2) people are required to rotate or to move the bed base. Do not drag across the floor. Do not rest frame on its side, excessive pressure may damage the legs.**

- 9 Plug the power cord into a surge protector or power outlet. **Note:** A surge protector is recommended.

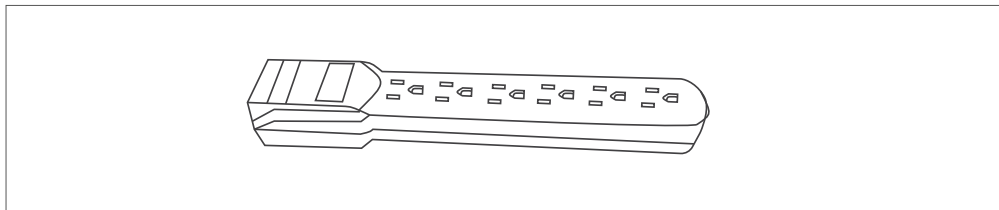

- 10 Insert the ends of the mattress retainer bar into the holes at the foot of the platform.

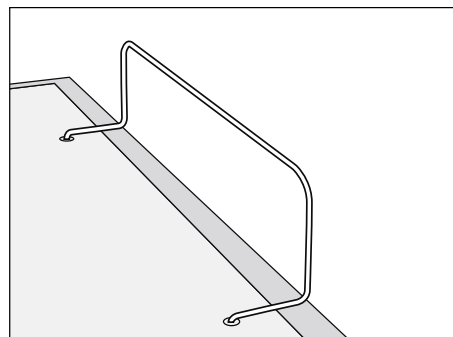
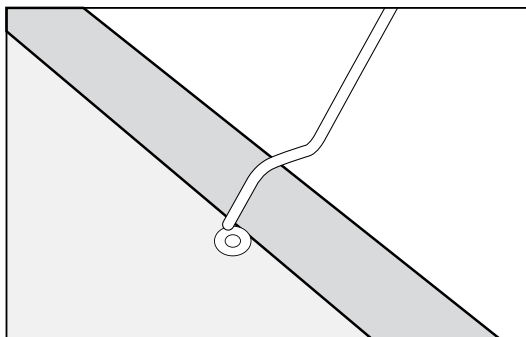

## Installation Guide (continued)

---

- 11 Ensure batteries are correctly installed in the back of the remote control. Test remote control functions to verify proper setup before placing mattress on base. Return the base to a flat position before placing the mattress on top.
- 12 To operate the base from a smart device, the “ErgoWellness” application must be downloaded to the desired smart device from the App Store (Apple) or Google Play Store (Android).

**Setup is now complete!**

# Remote Control

The remote controls arrive paired to the adjustable base. Three (3) AAA batteries are included and required to operate the remote.

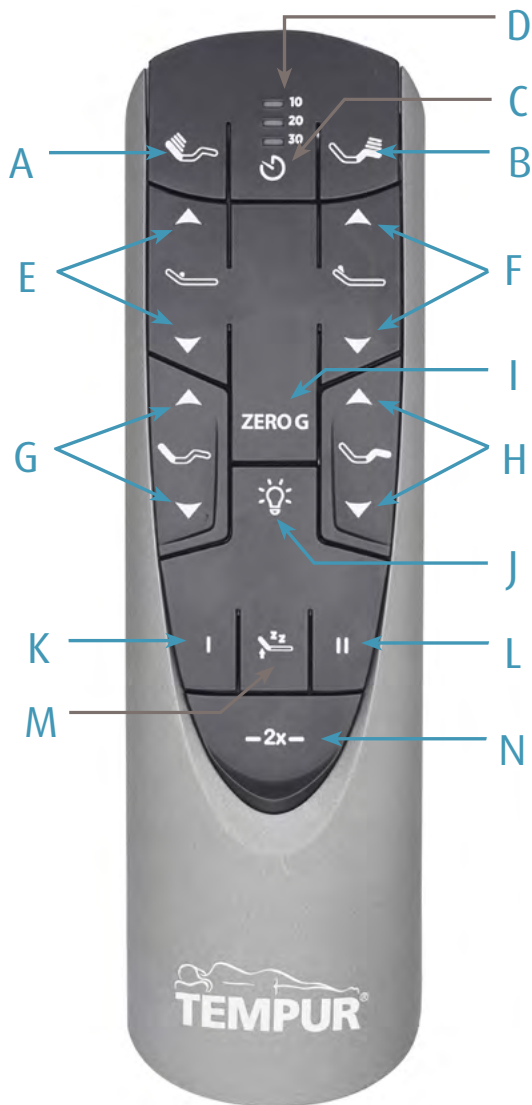

## REMOTE FUNCTIONS

- A. Head Massage: Cycle through 3 head massage intensities (Low > Medium > High > Off) After 10 minutes, massage timer will automatically turn off.
- B. Foot Massage: Cycle through 3 foot massage intensities (Low > Medium > High > Off) After 10 minutes, massage timer will automatically turn off.
- C. Massage Timer/All Off: The TIMER/ALL OFF button starts massage at level 2. Select a 10, 20 or 30 minute massage interval. Pressing a fourth time will turn off massage.
- D. Massage Timer Indication Lights: The lights on the top of the remote indicate a 10, 20 or 30 minute timer setting. Massage will automatically shut off after 10 minutes if the massage timer isn't set.
- E. Head Tilt Adjustment: Increases and decreases the head support.
- F. Lumbar Adjustment: Increases and decreases the lumbar support.
- G. Head Articulation: Raises and lowers the head end of the adjustable base.
- H. Foot Articulation: Raises and lowers the foot end of the adjustable base.
- I. Zero-G®: Preset position that adjusts your legs to a higher level than your heart helping to relieve pressure off the lower back and promote circulation.
- J. Dimmable Underbed Lights: Turn the underbed lights On/Off. Press and hold to adjust brightness.
- K. Programmable Preset I\*: Save a customizable position.
- L. Programmable Preset II\*: Save a customizable position.
- M. Anti-Snore: Raises the head of the bed slightly to help open airways and reduce snoring.

# Remote Control Programming & Child Lock

This remote control is programmed with a **Child Safety Lock** function and three programmable presets.



## **CHILD SAFETY LOCK**

- **LOCK:** Press and hold FLAT and RAISE HEAD (Side A) buttons for three (3) seconds. When the backlight on the remote flashes twice, the lock is completed; If any button is pressed while under the lock status, the backlight on the remote will flash twice.



- **UNLOCK:** Press and hold FLAT and RAISE FEET buttons for three (3) seconds. When the backlight on the remote flashes twice, the unlock is completed and the remote will operate normally.



### **\*TO PROGRAM THE PRESET POSITIONS:**

1. Articulate the head, foot and lumbar to your desired position.
2. Next, press and hold one of the preset buttons [**I or II**] for 5 seconds. The position is now saved.

**NOTE:** To restore the preset buttons back to their original factory settings, hold **FLAT** and **ZERO-G®** simultaneously for at least 5 seconds. The original presets will be restored.

# Remote Control Pairing

The original remote that comes in the box is already paired to the adjustable base. No further action is required. In the event that the remote is not paired with the base, follow the steps below.

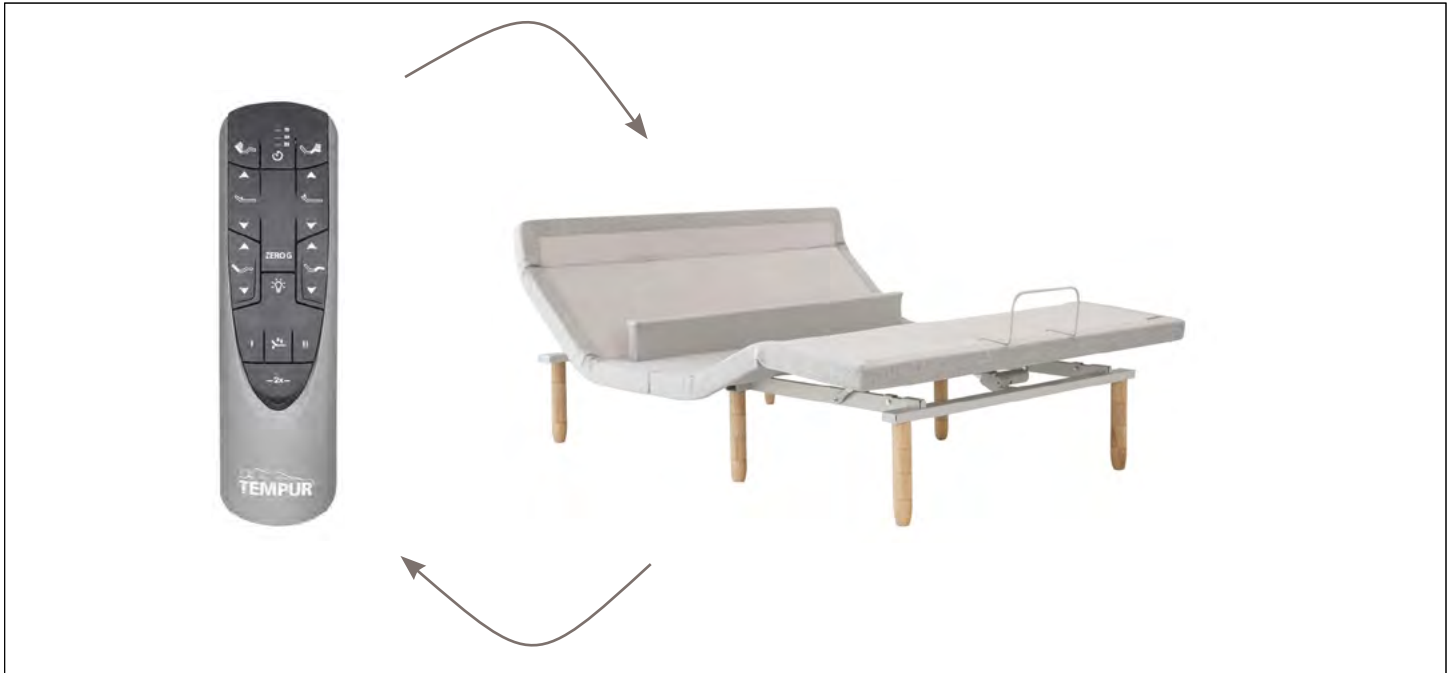

- 1 Unplug the Power Cord from your power outlet. Wait 1 minute, then plug it back in to your power outlet. Perform Step 2 within 10 seconds, while the control box light is flashing.
- 2 Remove the cover on the back of one remote and hold the PAIR button. The PAIR button will illuminate and start to flash. When the PAIR button stops flashing, the pairing LED light on the control box will stop illuminating. Release the PAIR button on the remote. Repeat steps 1 and 2 for the second remote.

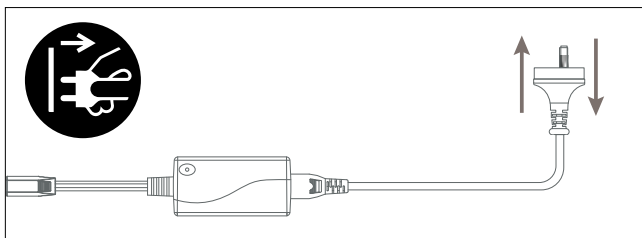

- 3 Test all remote functions. If the remote buttons do not impact the adjustable base movements, please repeat the process again or call customer service.

## Connecting Strap (optional)

If a split setup is being installed, optional plastic connecting straps can be used to help secure the bases together. To purchase optional accessories, please call customer service.

- 1 With the bases in their desired location, slightly loosen both legs to allow the strap to fit on the leg bolt, between the leg washer and frame.
- 2 Slide side (a) of the connecting strap onto leg bolt. Swing the strap and connect side (b) to the leg bolt. Secure the strap by shifting to the left.

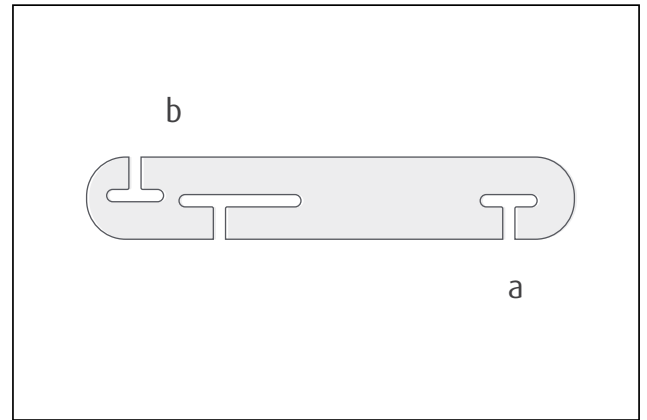
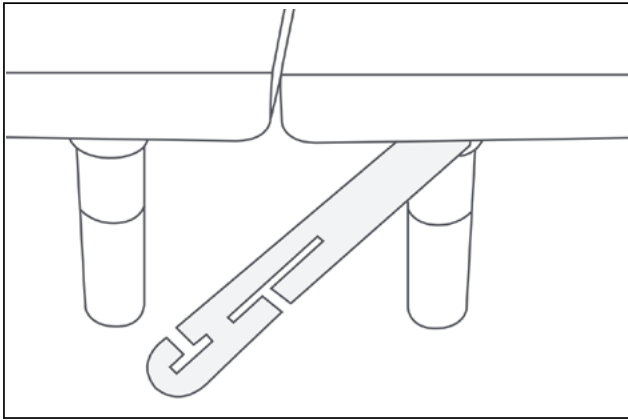

- 3 Re-tighten legs. Do not over tighten. Use the remaining strap and repeat on other end of the base.

## Syncing Two Bases (optional)

A Sync Cord is included with the base. Not available on Queen size base. The Sync Cord connects the two control boxes to a single remote for the synchronization of two bases. This process is most commonly used for syncing two connected LS bases.

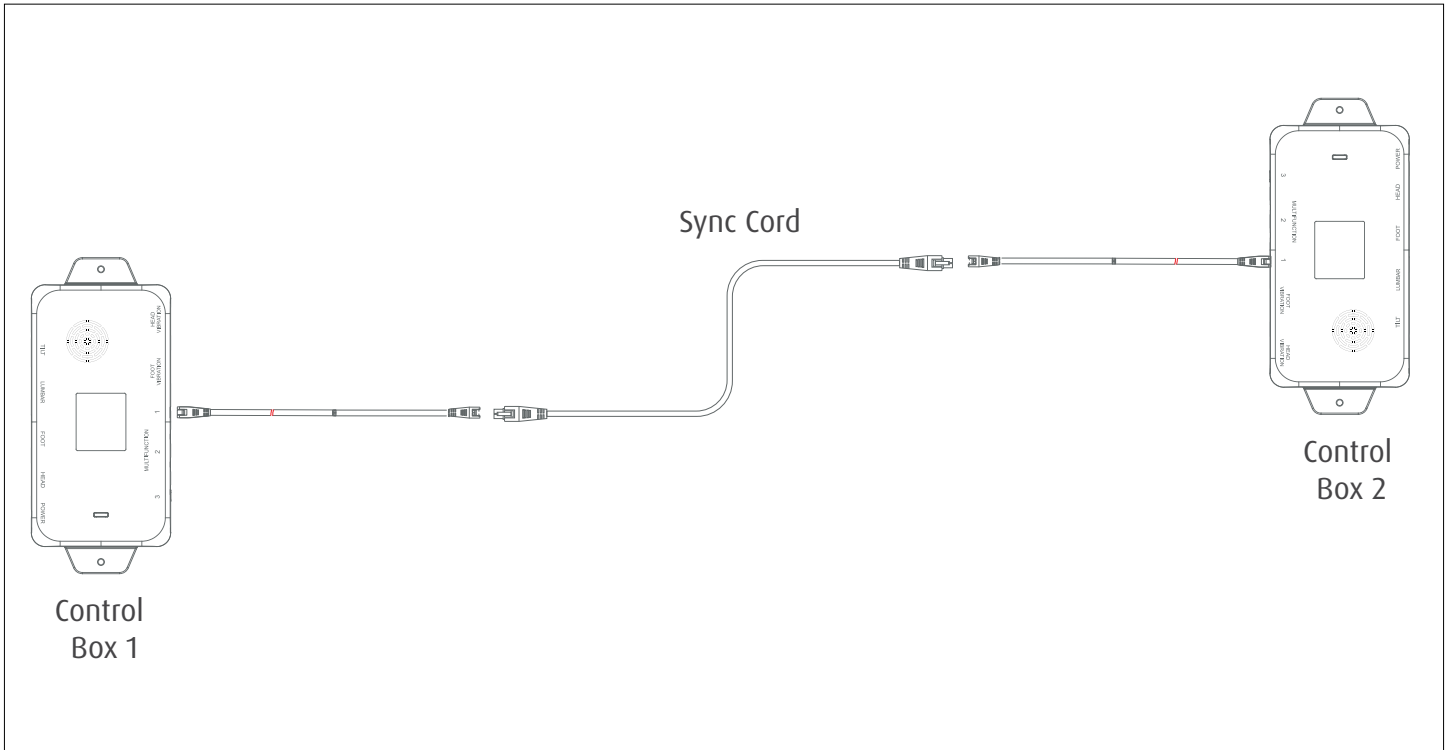





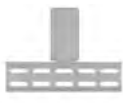

- 1 Unplug the base(s) from power source.
- 2 Connect the Sync Cord to the open connection on the Multifunction port of each Control Box.
- 3 Plug bases back into the power source.
- 4 Check to ensure all cords are securely attached. Both remotes will now operate both bases simultaneously.

**Note:** If bases become mismatched, returning the bases to the flat positions will re-sync the mechanical positions.

# Headboard Bracket Installation (not included)

Headboard Brackets are an optional accessory and are not included.  
A hex key is included with the accessory kit to complete installation.

K. 	L.  (King size)	 (Queen size)	M. 	K) Left and Right Headboard Bracket L) T-Bracket (2) M) Long Bolts (8) N) Medium Bolts (2) O) Short Bolts (4) P) Wingnuts (2) Q) Washers (2) R) Hex Key
N. 	O. 	P. 	Q. 	

- A. Align the hole in the bracket to the brass sleeve into which the leg threads. Hold the bracket in place and screw the leg into the base until it is snug. **DO NOT OVERTIGHTEN.** Too much force may cause the leg to spin freely.

B. Align the headboard bracket tab with the hole in the frame (located towards the foot of the base) and use a medium bolt, washer and wingnut to secure the bracket. Make sure the bolt is tight.

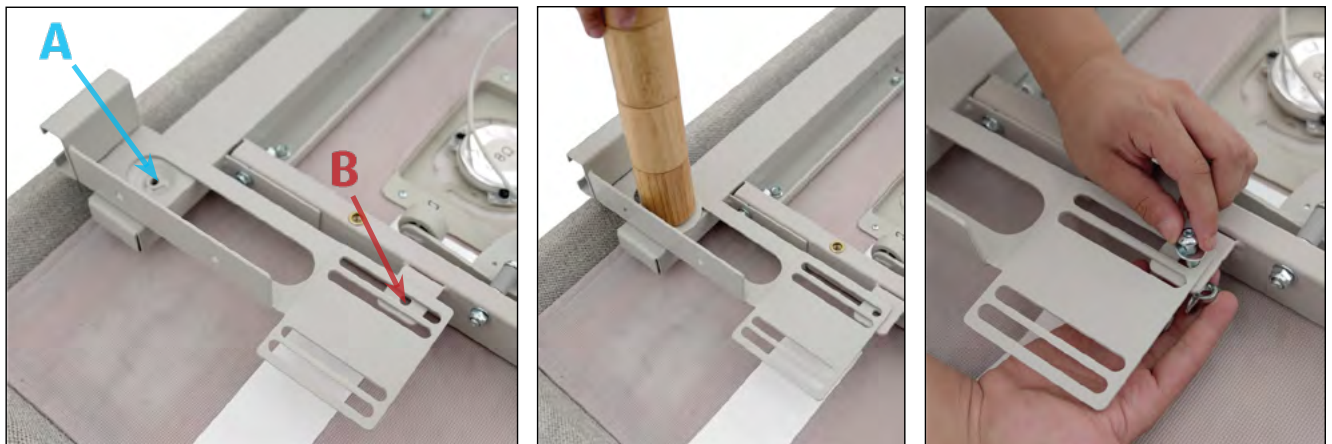

- A. Measure the distance between the mounting holes on the headboard and install the T-Bracket to accommodate the headboard.

B. To install the T-Bracket, slide the T-Bracket through the end of the headboard bracket. Align the flat side of the T-Bracket plate to the mounting holes on the headboard. Note: A king size T-Bracket is installed facing outward, while a Queen size T-Bracket should be installed facing inward.

C. Secure T-Bracket in place by inserting two short bolts through top of bracket. Use hex key to tighten.

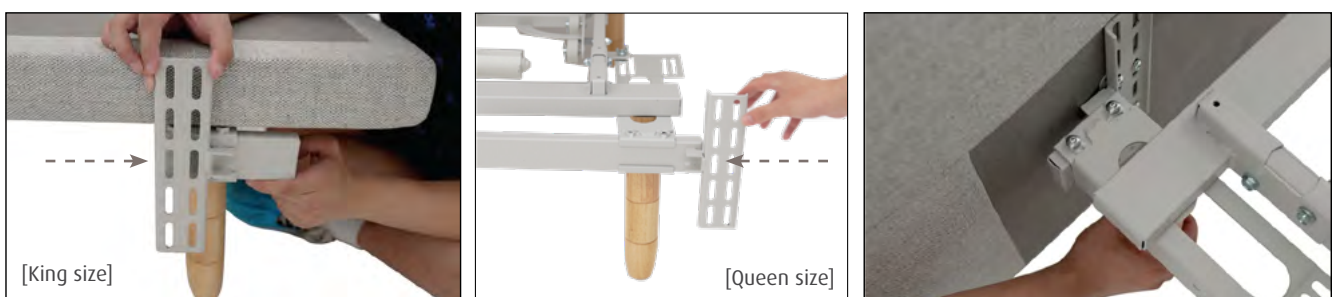

- 3 You may now connect your headboard to the attachment plate using the remaining long bolts to secure it to the brackets. The heads of the bolts will face outward. Use a hex key to tighten the bolts.

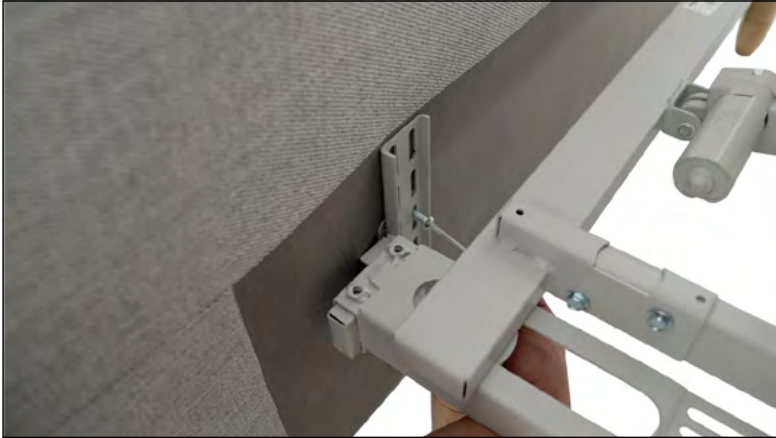

# Battery Backup Strap

For emergency use only, in case of a power outage. Batteries are not to be used for normal operation of the bed.

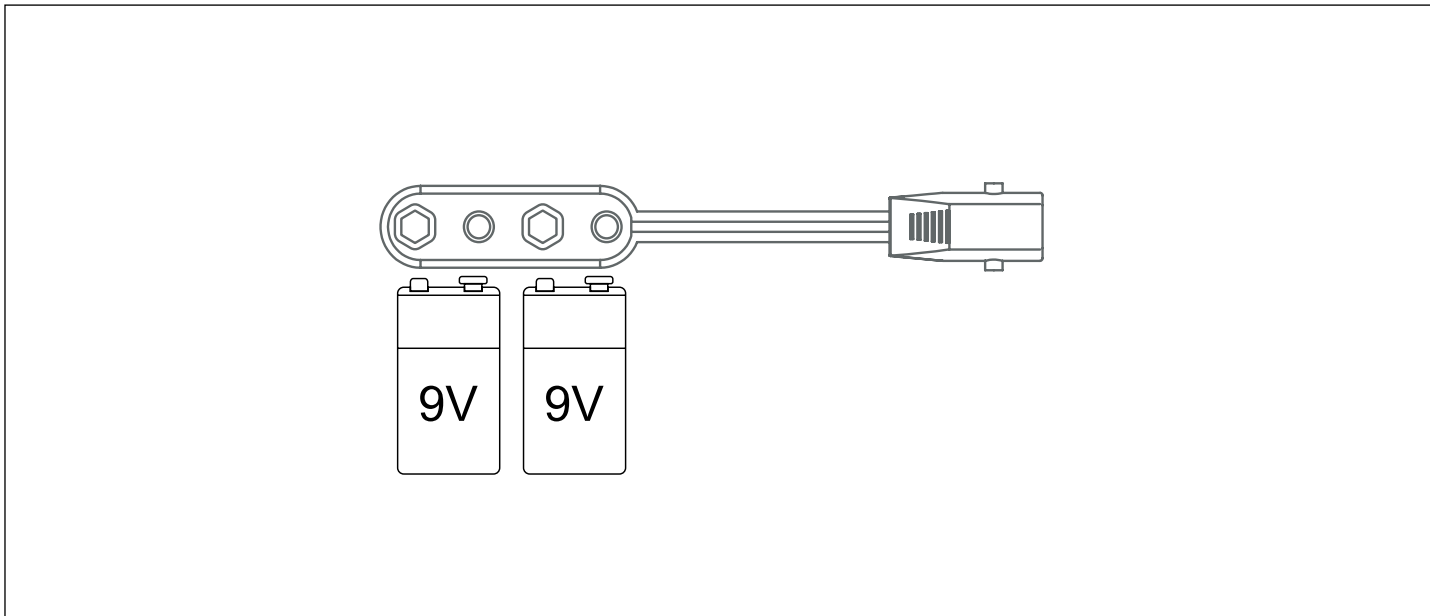

**1** Disconnect the Power Supply from the input power cord.

**2** Connect the Battery Backup Strap to the input power cord.

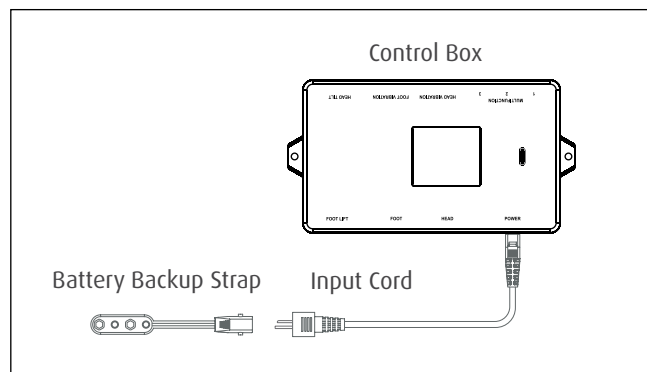
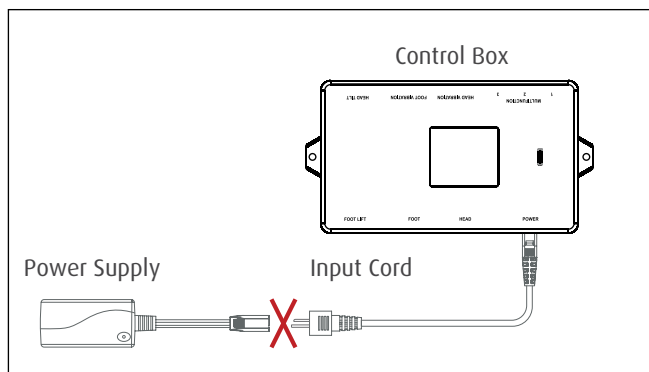

**3** Connect the Battery Backup Strap to two (2) Volt Alkaline batteries.

**4** Use the remote to return the base to a flat position.

**Note:** Do not mix brand name batteries.

**Note:** Detach the Battery Backup Strap and reconnect the power supply after the emergency is over, as the system will continue to draw

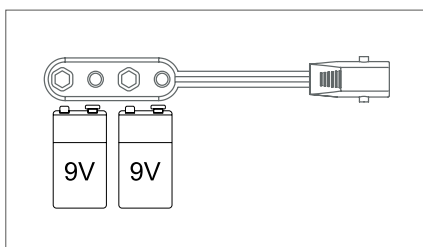

# Troubleshooting

## If one or more functions on the bed base have stopped operating:

- Check under the bed base to verify that the wired connections are secure and that there are no cords or bedding obstructing the movement of the base.
- Check to ensure the blue LED light is illuminated on the control box. If there is no light, verify that the input and power cords are properly connected.
- Unplug the base for 1 minute to reset the electronic components.
- Plug bed base into a different electrical outlet, or test current outlet with another working appliance (a grounded, electrical surge protector is recommended).
- Remove and replace full batteries in the remote control and re-pair the remote to the base (see [page 15](#)).
- Ensure Child Lock feature is not enabled. See [page 14](#) for more information.

If issue is not resolved by following the instructions above, locate serial number on warranty card or back of remote and call customer service.

# 10 Year Warranty

Warranty Registration: [australiasupport@ergomotion.com](mailto:australiasupport@ergomotion.com)

Please provide your adjustable base serial number and prepare a digital copy of your proof of purchase (invoice or sales receipt) when registering.

## 2-Year Hassle Free Warranty

Your adjustable base is warranted by the manufacturer against defects in materials or workmanship for a period of two years from the date of delivery to the original Purchaser. During such time, the manufacturer will repair or replace, at no cost to the original Purchaser, any warranted part(s)\* found to be defective by the manufacturer, in its sole discretion. This includes all pre-authorized labor and transportation costs incurred with the repair or replacement of any part found to be defective.

## 5-Year Warranty on Parts

During year 3 through 5 from the original delivery date, the manufacturer will replace any part on the adjustable base found to be defective by the manufacturer, to the original Purchaser. The manufacturer's liability is limited to the replacement of the defective electrical/mechanical part(s)\* ONLY, with the Purchaser responsible for all service, installation, and transportation cost of said part(s).

## 10-Year Limited Warranty

Notwithstanding the above, the manufacturer extends a 10-year warranty on mechanical base parts found to be defective on a limited basis as defined herein. Specifically, the manufacturer warrants that for a full 10 years from the commencement date of this warranty, any defect in the workmanship or the materials used shall be covered. For purposes of this 10-year warranty, it specifically excludes the cover, shroud, platform, legs, actuator lift motors, massage motors, control box, remote controls, power supply, and all power supply cords. The purchaser shall pay 1/5 of the current MSRP of the replacement part, or the entire adjustable base if deemed irreparable at the sole discretion of the manufacturer, multiplied by the number of years after the fifth year from the original delivery date. The manufacturer's liability shall be limited to the replacement of the defective part(s) ONLY with the purchaser responsible for all service, installation and freight costs for said part.

## Additional Terms & Conditions

This warranty does not include reimbursement/replacement for inconvenience, removal, part(s) installation, bed set up, loss of use, normal wear and tear, shipping or any other costs or expenses not expressly covered in this warranty. In addition, this warranty shall be void in the following circumstances:

- A. Damage resulting from misuse or abuse caused by the Purchaser or any third party.
- B. Damage caused by repairs or parts replacement by an unauthorized person.
- C. Damage caused if the adjustable base has been mishandled (including during shipping), subject to physical abuse or an improper power supply, or by failing to adhere to the Owner's Manual and this warranty.
- D. Damaged mattresses, foundation cover(s), fabric(s), bedding cables, electrical cords or accessories supplied by dealers or any third party. Contact your dealer for warranty information on these items.
- E. Modification of the adjustable base without prior written consent by the manufacturer.
- F. Costs for unauthorized service calls for the purpose of educating the consumer about the adjustable base or locating proper functioning power outlets.

# 10 Year Warranty

- G. Damage if the recommended weight restrictions are exceeded.
- H. Damage if used in any environment or a commercial setting which was not intended.
- I. This warranty requires notice to be given to Ergomotion of any claim for repairs or replacement parts.
- J. Damage to foam shroud by improper handling or misuse.

\*Parts include the following:

- a. Head/Foot Actuator
- b. Massage Motors and Housing
- c. Control Box
- d. Remote Control
- e. Power Cord, Power Supply, and Input Cord
- f. Mounting Brackets
- g. Support Struts

OTHER THAN AS EXPRESSLY SET OUT HEREIN, AND TO THE EXTENT PERMITTED BY APPLICABLE LAW, THIS WARRANTY IS EXCLUSIVE AND IN LIEU OF ALL OTHER ORAL OR WRITTEN WARRANTIES, REPRESENTATIONS, CONDITIONS OR PROMISES, WHETHER EXPRESS OR IMPLIED, AND WHETHER ARISING BY LAW, STATUTE, COURSE OF DEALING OR USAGE OF TRADE, INCLUDING, BUT NOT LIMITED TO, IMPLIED WARRANTIES AND CONDITIONS OF MERCHANTABILITY, QUALITY, DURABILITY AND/OR FITNESS FOR A PARTICULAR PURPOSE. TO THE EXTENT PERMITTED BY APPLICABLE LAWS, ANY IMPLIED WARRANTIES (IF APPLICABLE) ARE LIMITED IN DURATION TO THE DURATION OF THIS WARRANTY. TO THE EXTENT PERMITTED BY APPLICABLE LAW, IN NO EVENT SHALL THE MANUFACTURER BE LIABLE FOR ANY SPECIAL, INCIDENTAL, PUNITIVE, EXEMPLARY, CONSEQUENTIAL, LIQUIDATED OR SIMILAR DAMAGES, WHETHER OR NOT FORESEEABLE.

Note: The exclusion directly above is inapplicable to consumers residing in Québec.

To the extent permitted by law, this warranty is not transferable and will automatically terminate if the original Purchaser sells or otherwise disposes of the adjustable base.

This warranty gives the Purchaser specific legal rights. Other rights, which vary from jurisdiction to jurisdiction, may exist. In addition, some jurisdictions do not allow (i) the exclusion of certain warranties, (ii) limitations on how long an implied warranty lasts and/or (iii) the exclusion or limitation of certain types of costs and/or damages, so the above limitations may not apply.

This warranty is only valid in The United States, Canada and Puerto Rico. For all other jurisdictions, this Limited Product Warranty is valid only in the jurisdictions where the Products are sold by an Ergomotion authorized reseller or agent and is valid to the extent permitted by the applicable laws of such jurisdictions.

## Weight Limits

This product is not rated to support weights exceeding 750 pounds (340kg). This product is not rated to support weights in excess of 750 pounds inclusive of the mattress and bedding. The base will structurally support this weight, provided it is evenly distributed across the bed base. The adjustable base is not designed to support or lift this amount in the head or foot sections alone. Exceeding this weight restriction could damage the bed and/or cause injury and will void the warranty.

# Customer Service

AU: 1800 616 882 | NZ: 613 52 777 105